



CURV 500[®] SERIES

INSTALL SOLUTIONS

CONFIGURATION GUIDE

CURV 500 iAMP
CURV 500 SPEAKERS



BISTRO

Bistros, cafés, clubs or restaurants often require audio systems with a multi-zone layout. The modular design of the CURV 500 installation system enables individual configurations for each zone ranging from subtle background music to dancefloor levels while keeping the same excellent sonic signature throughout the installation.

CURV 500® INSTALL

BISTRO MEDIUM BUNDLE / 12 SATELLITES AND 2 SUBWOOFERS

ZONE 1



ZONE 2

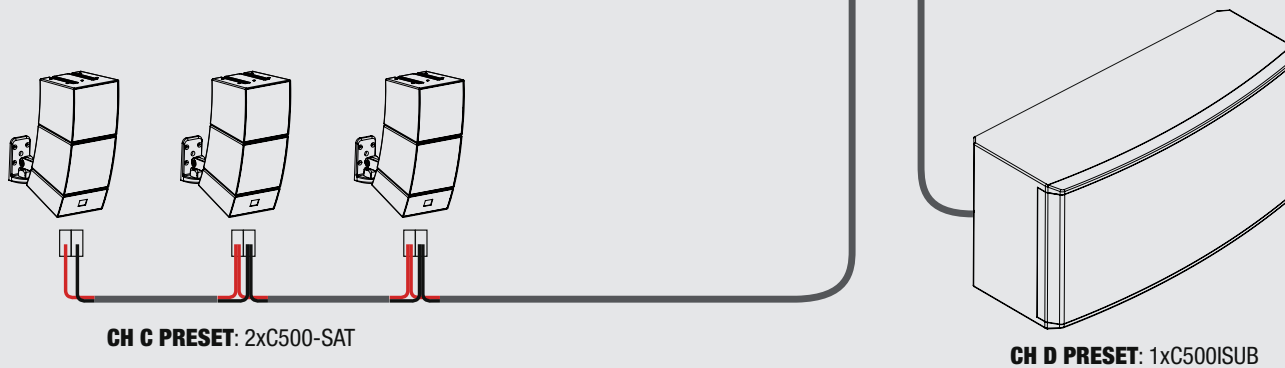

CURV 500 iAMP OUTPUT
4 balanced mono line inputs, assignable to any output, in any combination, thanks to the internal routing matrix.

CURV 500® INSTALL

BISTRO MAX BUNDLE / 12 SATELLITES AND 2 SUBWOOFERS

ZONE 1

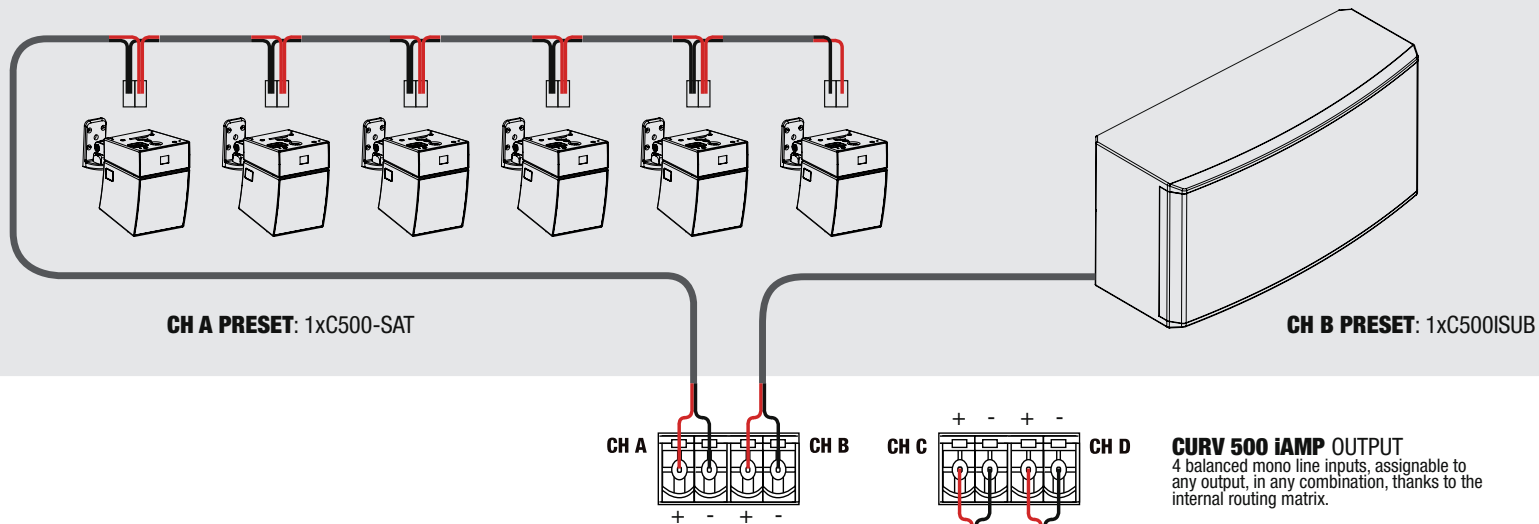

ZONE 2

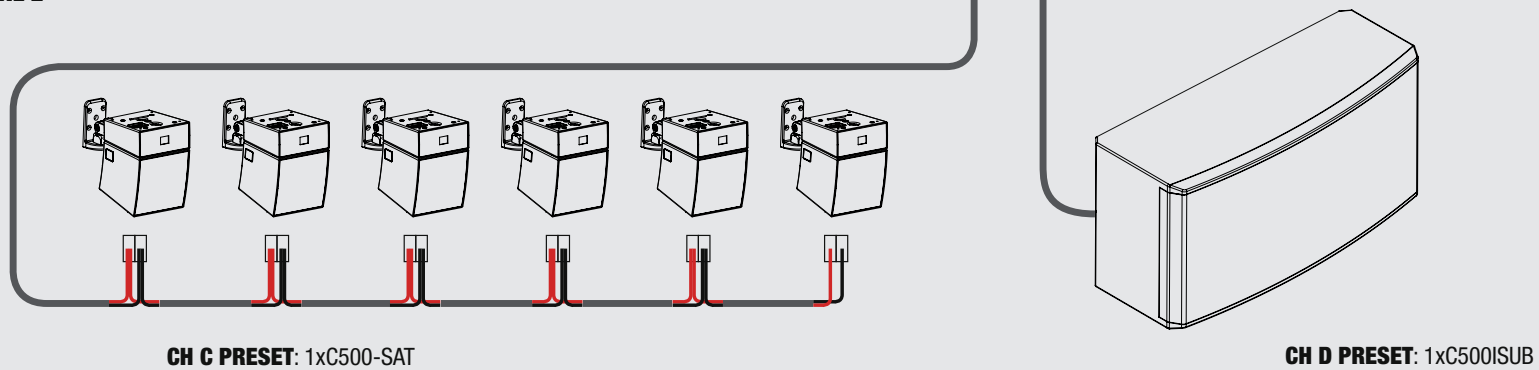

CONFERENCE

In addition to excellent speech intelligibility, conference and meeting room audio systems must deliver superb sound reproduction for multimedia applications.

With its modular design and elegant appearance, the CURV 500 is the perfect choice for all installation sizes from small meeting rooms to large multipurpose spaces.



CURV 500® INSTALL

CONFERENCE MEDIUM BUNDLE / 8 SATELLITES AND 1 SUBWOOFER

FRONT



CH A PRESET: 2xC500-SAT

CH B PRESET: 2xC500-SAT

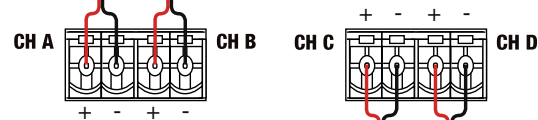

CURV 500 iAMP OUTPUT
4 balanced mono line inputs, assignable to any output, in any combination, thanks to the internal routing matrix.

REAR

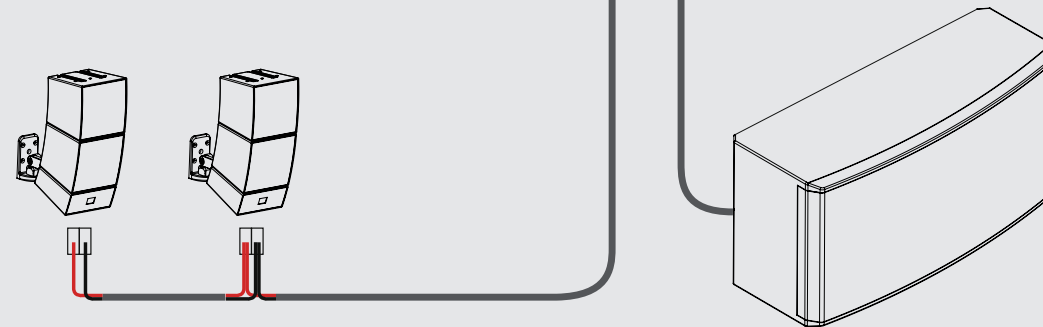

CH C PRESET: 2xC500-SAT

CH D PRESET: 1xC500ISUB

CURV 500® INSTALL

CONFERENCE MAX BUNDLE / 12 SATELLITES AND 2 SUBWOOFERS

ZONE 1 / FRONT

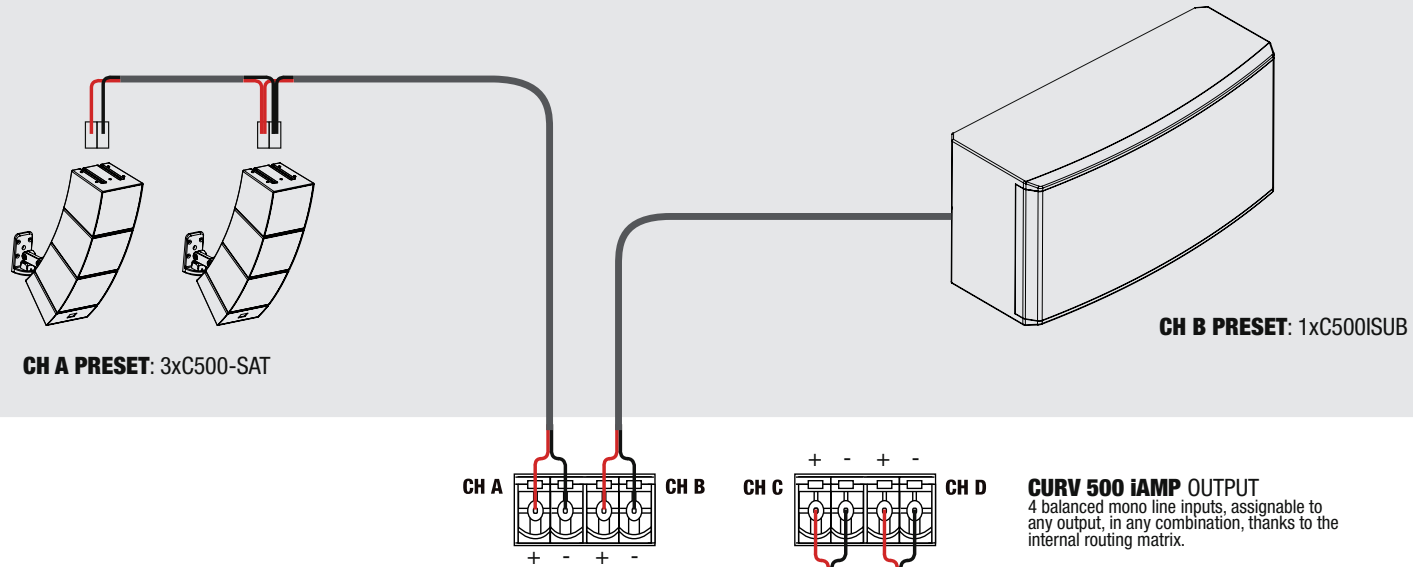

ZONE 2 / REAR

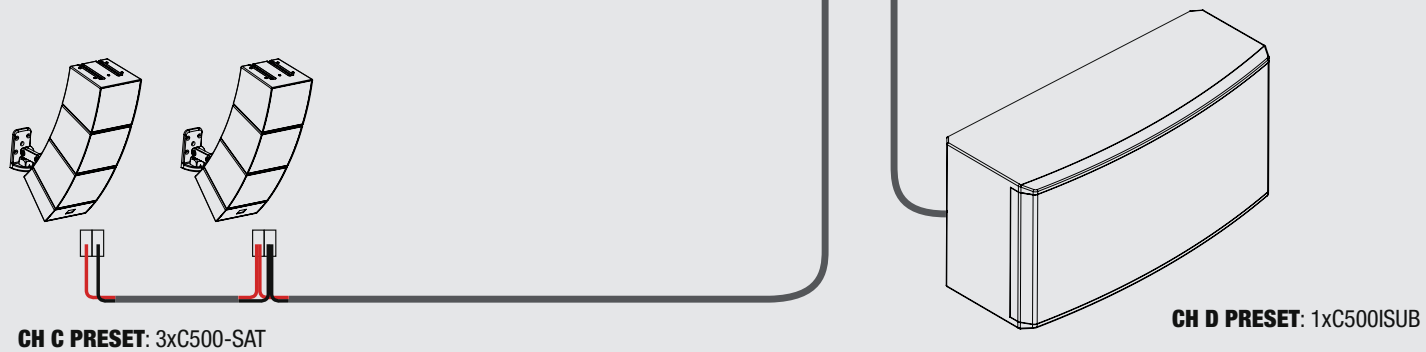

VOICE

Audio installations for speech reproduction only such as those in lecture rooms typically do not require sub frequency reinforcement. The CURV 500 system's iAMP provides delay compensation per channel to ensure maximum speech intelligibility, imaging and sound quality throughout the installation.



CURV 500® INSTALL

VOICE BUNDLE / 24 SATELLITES

ZONE 1

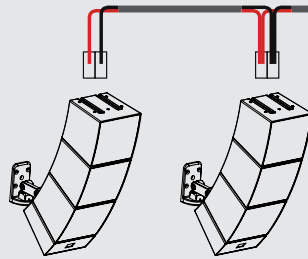

CH A PRESET: 3xC500-SAT

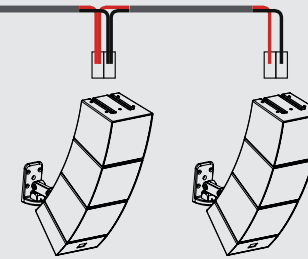

CH B PRESET: 3xC500-SAT

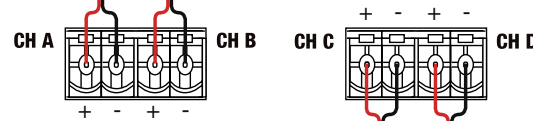

CURV 500 iAMP OUTPUT
4 balanced mono line inputs, assignable to any output, in any combination, thanks to the internal routing matrix.

ZONE 3

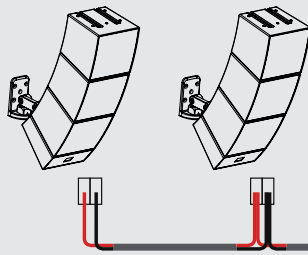

CH C PRESET: 3xC500-SAT

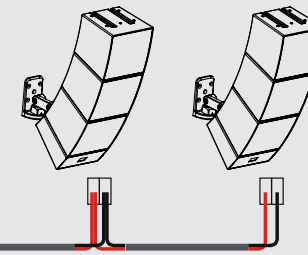

CH D PRESET: 3xC500-SAT

CURV 500® INSTALL

VOICE MAX BUNDLE - 24 SATELLITES

CH A PRESET: 1xC500-SAT

CH B PRESET: 1xC500-SAT

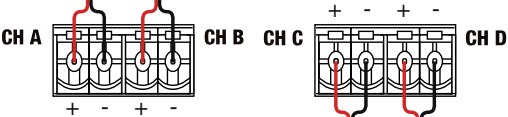
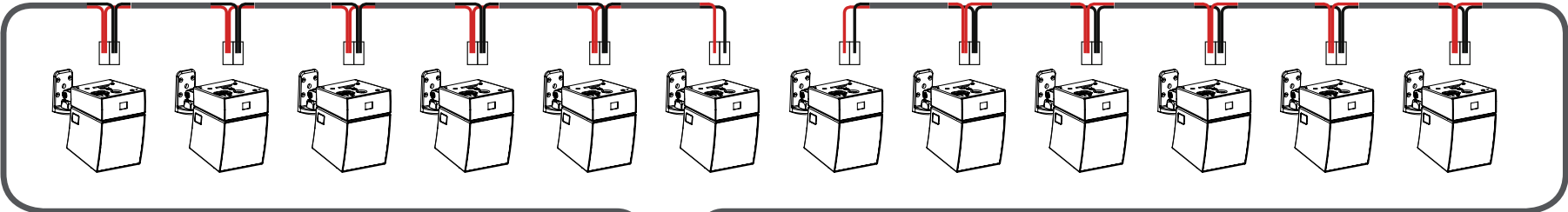

CURV 500 iAMP OUTPUT
4 balanced mono line inputs, assignable to any output, in any combination, thanks to the internal routing matrix.

CH C PRESET: 1xC500-SAT

CH D PRESET: 1xC500-SAT

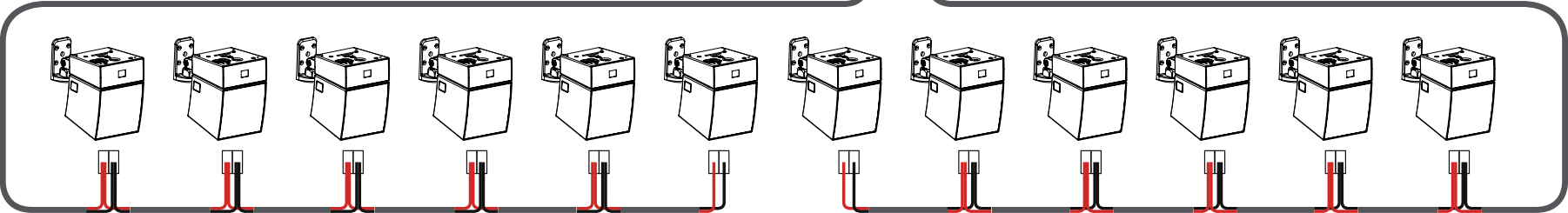

70V

The CURV 500's iAMP includes 70V output to deliver audio to a large number of speakers. This permits setting up a distributed system by daisy-chaining a maximum of 24 satellites to bridged channel A and B outputs, or bridged channel C and D outputs. The satellites can be wired individually or in groups of 2, 3 or 4 units.



CURV 500® INSTALL

70V EXAMPLE - 1 SATELLITE SET / MAX. 24 SATELLITES PER BRIDGED OUTPUT

ZONE 1 - SATELLITES

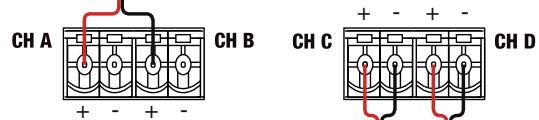
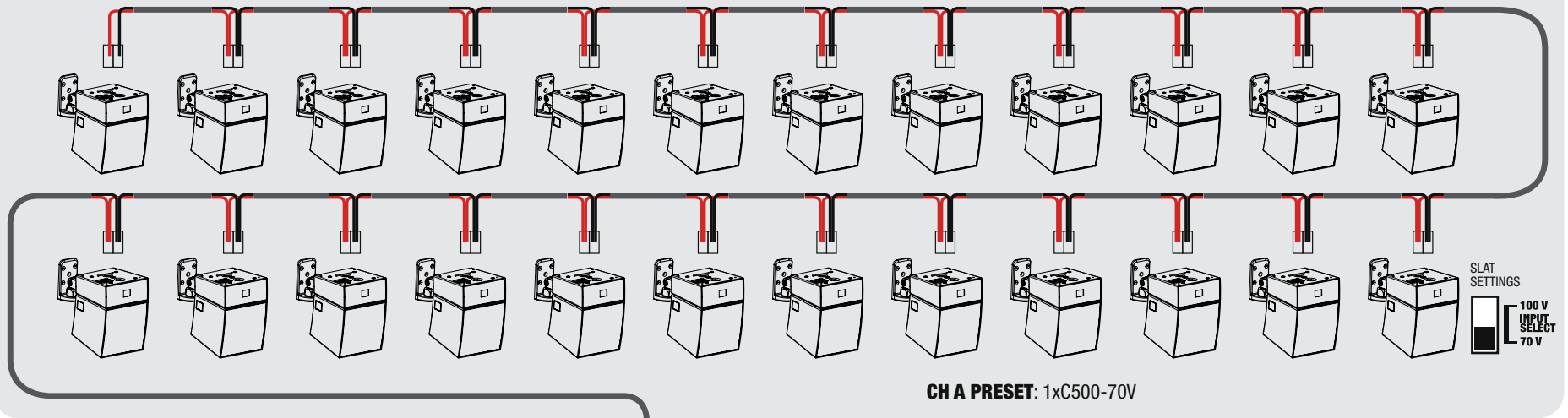

CURV 500 iAMP OUTPUT
4 balanced mono line inputs, assignable to any output, in any combination, thanks to the internal routing matrix.

ZONE 1 - SUBWOOFERS

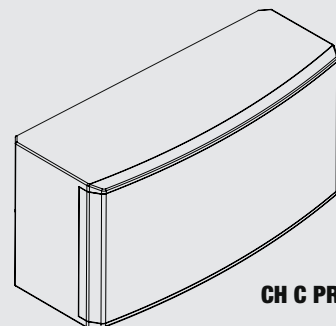

CH C PRESET: 1xC500ISUB

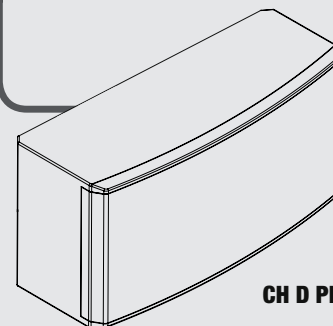

CH D PRESET: 1xC500ISUB

CURV 500® INSTALL

70V EXAMPLE - 2 SATELLITE SETS / MAX. 24 SATELLITES PER BRIDGED OUTPUT

ZONE 1 - SATELLITES

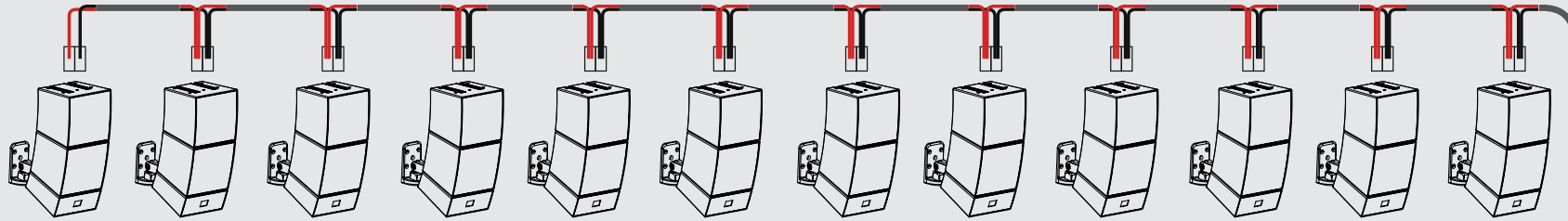

CH A PRESET: 2xC500-70V

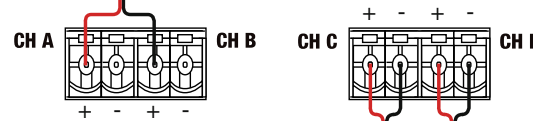
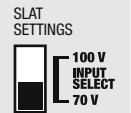

CURV 500 iAMP OUTPUT
4 balanced mono line inputs, assignable to any output, in any combination, thanks to the internal routing matrix.

ZONE 1 - SUBWOOFERS

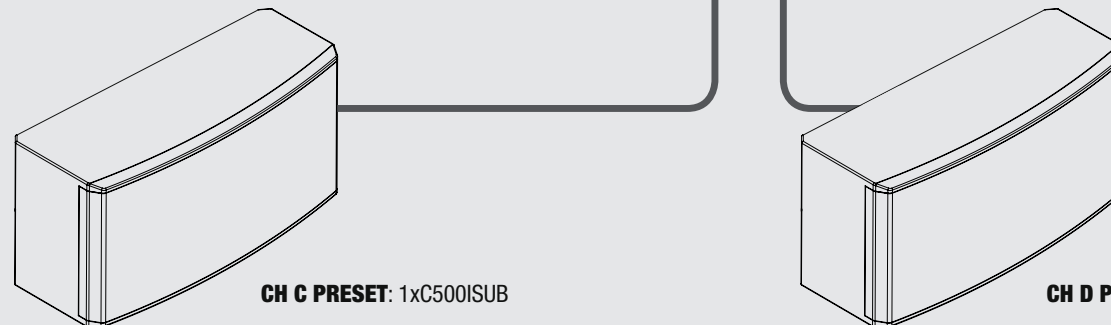

CH C PRESET: 1xC500ISUB

CH D PRESET: 1xC500ISUB

CURV 500® INSTALL

70V EXAMPLE - 3 SATELLITE SETS / MAX. 24 SATELLITES PER BRIDGED OUTPUT

ZONE 1 - SATELLITES

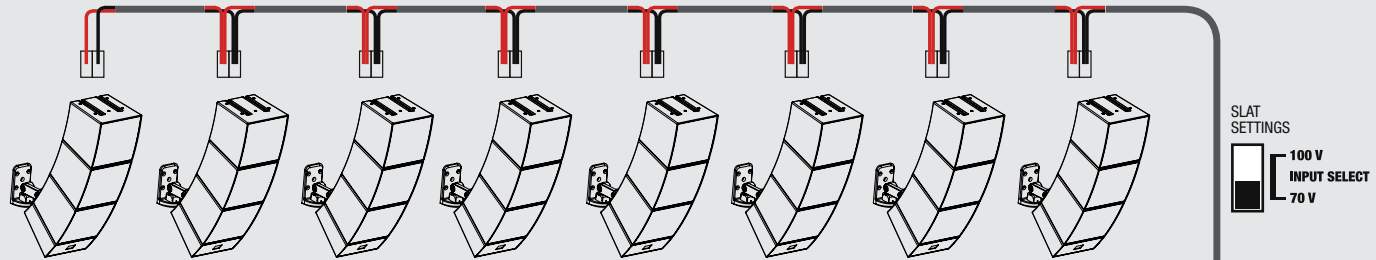

CH A PRESET: 3xC500-70V

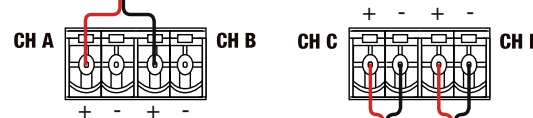

CURV 500 iAMP OUTPUT
4 balanced mono line inputs, assignable to any output, in any combination, thanks to the internal routing matrix.

ZONE 1 - SUBWOOFERS

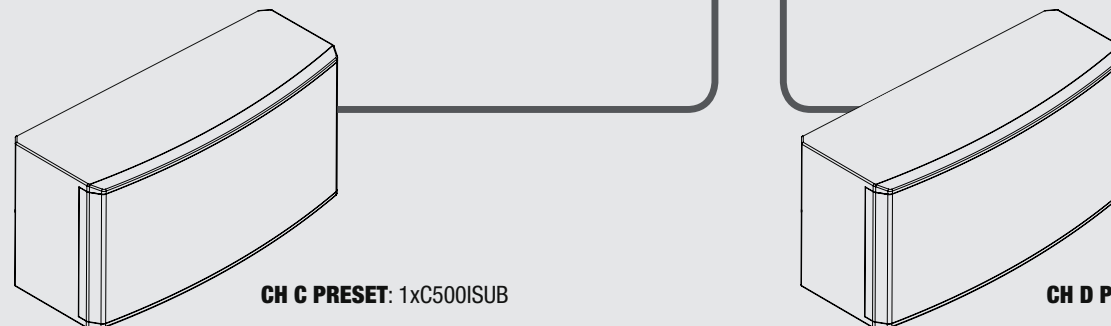

CH C PRESET: 1xC500ISUB

CH D PRESET: 1xC500ISUB

CURV 500® INSTALL

70V EXAMPLE - 4 SATELLITE SETS / MAX. 24 SATELLITES PER BRIDGED OUTPUT

ZONE 1 - SATELLITES

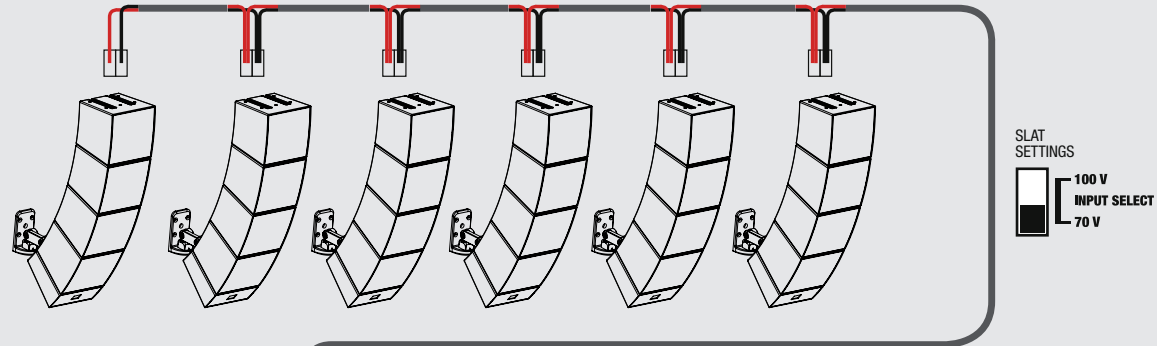

CH A PRESET: 4xC500-70V

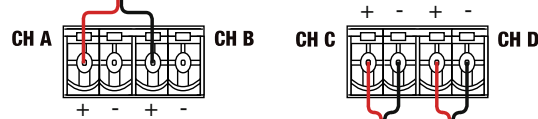

CURV 500 iAMP OUTPUT
4 balanced mono line inputs, assignable to any output, in any combination, thanks to the internal routing matrix.

ZONE 1 - SUBWOOFERS

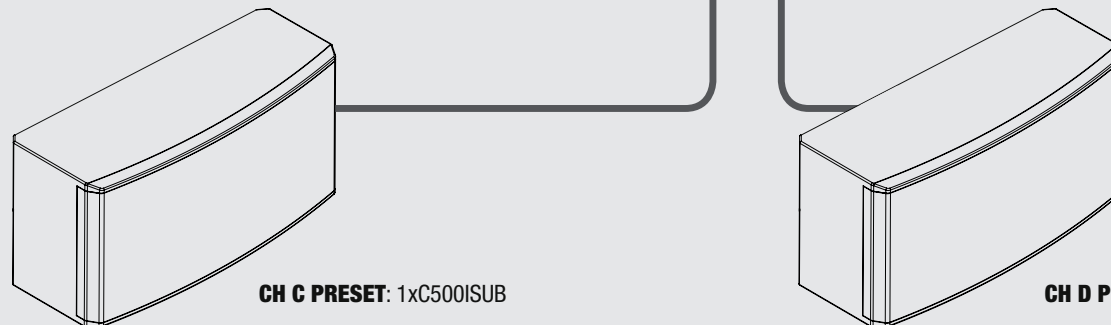

CH C PRESET: 1xC500ISUB

CH D PRESET: 1xC500ISUB

SHOPPING LIST CURV 500® INSTALL SOLUTIONS

BISTRO MEDIUM

Devices

QTY	Model	Article Nr.	Comments
1	CURV 500 IAMP	LDCURV500IAMP	
2	CURV 500 ISUB	LDCURV500ISUB	Black and white colours available
6	CURV 500 SLA	LDCURV500SLA	Black and white colours available
6	CURV 500 S2	LDCURV500S2	Black and white colours available

This bundle requires six mounting accessories. Please check pages 19 and 20 for information about our wall, ceiling and truss mounting accessories.

BISTRO MAX

Devices

QTY	Model	Article Nr.	Comments
1	CURV 500 IAMP	LDCURV500IAMP	
2	CURV 500 ISUB	LDCURV500ISUB	Black and white colours available
12	CURV 500 SLA	LDCURV500SLA	Black and white colours available
6	CURV 500 S2	LDCURV500S2	Black and white colours available

This bundle requires 12 mounting accessories. Please check pages 19 and 20 for information about our wall, ceiling and truss mounting accessories.

CONFERENCE MEDIUM

Devices

QTY	Model	Article Nr.	Comments
1	CURV 500 IAMP	LDCURV500IAMP	
1	CURV 500 ISUB	LDCURV500ISUB	Black and white colours available
4	CURV 500 SLA	LDCURV500SLA	Black and white colours available
4	CURV 500 S2	LDCURV500S2	Black and white colours available

This bundle requires 4 mounting accessories. Please check pages 19 and 20 for information about our wall, ceiling and truss mounting accessories.

CONFERENCE MAX

Devices

QTY	Model	Article Nr.	Comments
1	CURV 500 IAMP	LDCURV500IAMP	
2	CURV 500 ISUB	LDCURV500ISUB	Black and white colours available
4	CURV 500 SLA	LDCURV500SLA	Black and white colours available
6	CURV 500 S2	LDCURV500S2	Black and white colours available

This bundle requires 4 mounting accessories. Please check pages 19 and 20 for information about our wall, ceiling and truss mounting accessories.

VOICE

Devices

QTY	Model	Article Nr.	Comments
1	CURV 500 IAMP	LDCURV500IAMP	
8	CURV 500 SLA	LDCURV500SLA	Black and white colours available
12	CURV 500 S2	LDCURV500S2	Black and white colours available

This bundle requires 8 mounting accessories. Please check pages 19 and 20 for information about our wall, ceiling and truss mounting accessories.

VOICE MAX

Devices

QTY	Model	Article Nr.	Comments
1	CURV 500 IAMP	LDCURV500IAMP	
24	CURV 500 SLA	LDCURV500SLA	Black and white colours available
12	CURV 500 S2	LDCURV500S2	Black and white colours available

This bundle requires 24 mounting accessories. Please check pages 19 and 20 for information about our wall, ceiling and truss mounting accessories.

CURV 500® INSTALL PRODUCTS



CURV 500® iAMP

4-CHANNEL CLASS D INSTALLATION AMPLIFIER

- 4-Channels with DSP control
- Purpose-designed for CURV 500 installations
- Low-profile 1U 19" rackmount construction
- Drives up to 24 CURV500 satellites per bridged output in 70V mode
- Single push encoder operation
- High-contrast OLED display
- Temperature controlled low-noise fan
- High-efficiency switch mode power supply
- Only 6.8 kg



CURV 500® iSUB (W)

10" INSTALLATION SUBWOOFER 200 W IN BLACK OR WHITE

- 10" bass reflex construction
- Purpose-designed for CURV 500 installations
- Shallow-depth enclosure
- 200 watts RMS power handling
- 47 – 150 Hz frequency response
- Available in black or white textured paint finish
- Includes low-profile wall and ceiling mounting bracket

CURV 500® INSTALL PRODUCTS



CURV 500® S2 (W)

TWO ARRAY SATELLITES FOR THE CURV 500 ARRAY SYSTEM IN BLACK OR WHITE

- Bundle consisting of two array satellites
- Compact cabinet made of black die-cast aluminium, rugged and resilient
- A single 4-inch midrange driver and three 1-inch high-frequency drivers with patented WaveAhead® technology delivers excellent sound
- SmartLink® system allows for cable-free assembly of up to four array satellites
- 16 ohm impedance per satellite



CURV 500® SLA (W)

SMARTLINK® ADAPTER
IN BLACK OR WHITE

- For up to six CURV 500 satellites
- Base for CURV 500® system
- 2 x 16 mm flange for an optimised dispersion angle
- 4 x M6 threads for wall mounting
- 4 x M3 threads for ceiling mounting
- 4 rubber feet for desktop applications
- Speakon-compatible connection for usual speaker cables
- Rotating logo for ceiling mounting
- 2 pole - Euro Style terminal block connector (2 x 1.5 mm² speaker cable recommended)

CURV 500® INSTALL PRODUCTS

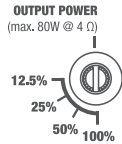

POWER SETTINGS IN TAP SELECTOR

No. of CURV 500 satellites	12,50%	25%	50%	100%
1	2W	5W	10W	20W
2	5W	10W	20W	40W
3	8W	15W	30W	60W
4	10W	20W	40W	80W



CURV 500® SLA(W)T

70 / 100 VOLT SMARTLINK® ADAPTER IN BLACK OR WHITE

- 70 / 100 V SmartLink® adapter for up to four LD CURV 500® satellites
- Integrated transformer with 10, 20, 40 and 80 W output taps @ 4 ohms
- Switchable for 70 or 100 V operation
- 2 x M6 threads for wall mounting
- 4 x M3 threads for ceiling mounting
- 4 rubber feet for desktop applications
- 2 pole - Euro Style terminal block connector (2 x 1.5mm² speaker cable recommended)
- Rotating logo for ceiling mounting
- Output power selector with four settings available
- If used in combination with an IAMP amplifier, INPUT SELECT should be set to 70V.

CURV 500® TMB

TRUSS CLAMP FOR CURV 500 SATELLITES

- Clamps to trusses and crossbars
- Tough black powder coating finish
- Includes Eyebolt M6 x 12 mm and washer
- Maximum load: 20 kg. It can hold up to six CURV 500 satellites plus one CURV 500 SLA adapter.

CURV 500® INSTALL PRODUCTS



CURV 500® WMB (W)

WALL MOUNTING BRACKET FOR CURV 500 SATELLITES IN BLACK OR WHITE

- Fully adjustable on all axes
- Tough black powder coat finish
- Comes with safety rope
- Maximum load: 10 kg. It can hold up to five CURV 500 satellites plus one CURV 500 SLA adapter.



CURV 500® CMB (W)

CEILING MOUNTING BRACKET FOR CURV 500 SATELLITES BLACK

- 360° rotatable
- Tough black or white powder coat finish
- Includes 20 cm steel safety rope
- Maximum load: 10 kg. It can hold up to five CURV 500 satellites plus one CURV 500 SLA adapter.

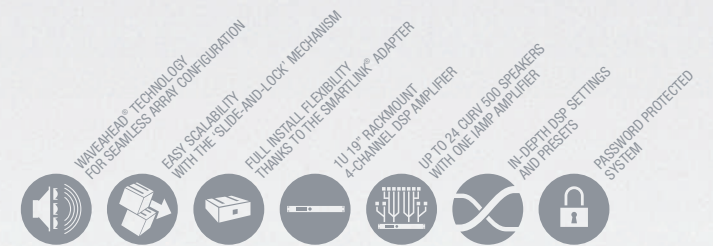

CURV 500® SERIES

INSTALL SOLUTIONS



Great sound can also be installed – combining unique design and modularity, ease of integration and professional audio performance, the CURV 500® series now features dedicated products for the professional install market. Now you can create fully integrated distributed systems with up to 24 CURV 500® speakers. Set yourself apart from the competition, give your customers more than what they want – inspire them!



DESIGNED & ENGINEERED IN GERMANY
WWW.LD-SYSTEMS.COM